

akustiksan®

AKUSTIKSANWOOD

*Wooden Panel Acoustical Systems*



@kustiksan®

# AKUSTIKSANWOOD

*Wooden Panel Acoustical Systems*

For world-class sound absorption & reverberation control, Akustiksancore wood  
Wooden panels offer the best solution. These panels are a wide range of perforated,  
grooved wooden wall & ceiling panels. These are available in a standard range of  
veneers and laminate surfaces. Their design is durable and offer invisible interlocking and  
concealed fixing systems to ensure a seamless fit.

## FEATURES

- Excellent Sound Absorption & Reverberation Control
- Fire Rated & Low Formaldehyde
- High Impact & Durable
- Black Felt Backing
- Invisible Interlocking & Concealed Fixing System

## FIXING DETAILS

### Linear Grooved Panels

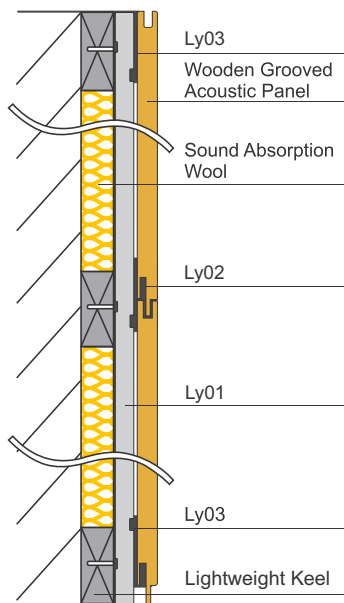

Cross-section Structure

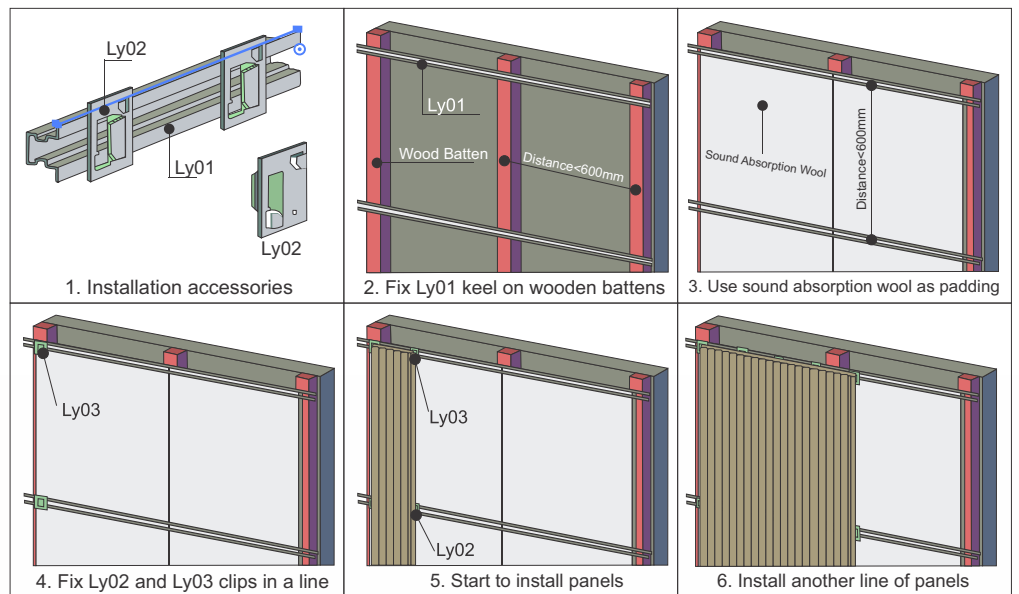

Installation: Lightweight Steel Keel System

### Perforated Tiles

#### Installation System I (with gap)

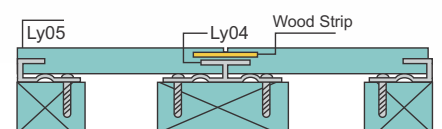
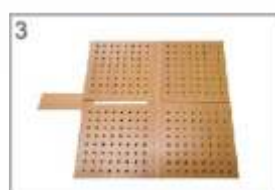

Cross-section Structure

#### Installation System II (without gap)

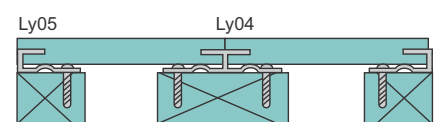

Cross-section Structure

# ABSORPTION COEFFICIENT



## Absorption Coefficient

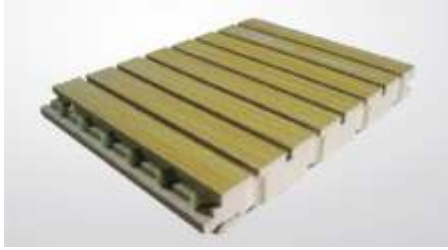

Pattern 13-3

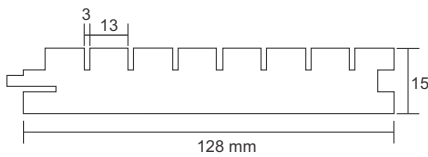

(Pattern 13-12) Perforation Rate:12%

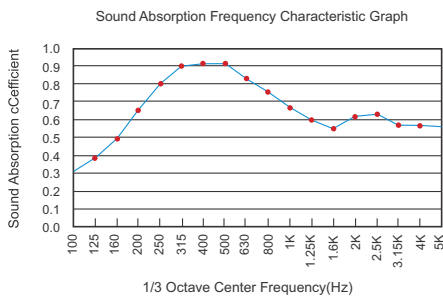

Pattern 14-2

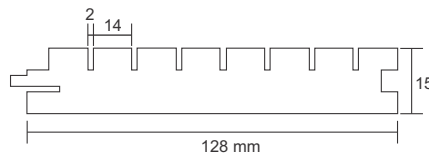

(Pattern 14-2) Perforation Rate:7.5%

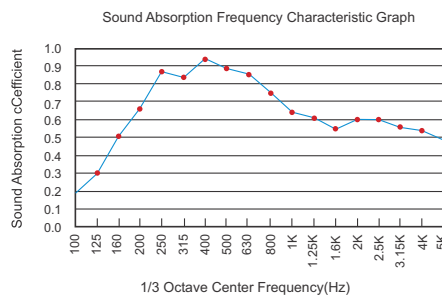

Pattern 28-4

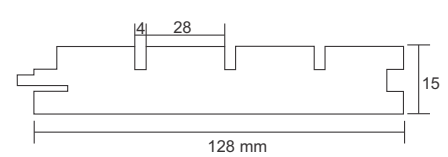

(Pattern 28-4) Perforation Rate:7%

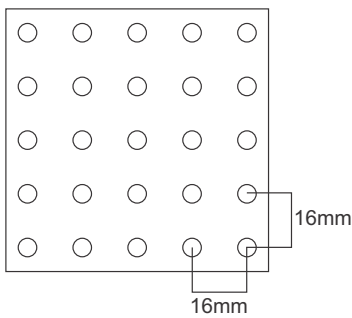
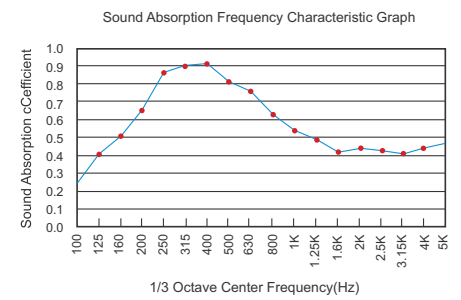

Pattern:16-16-6

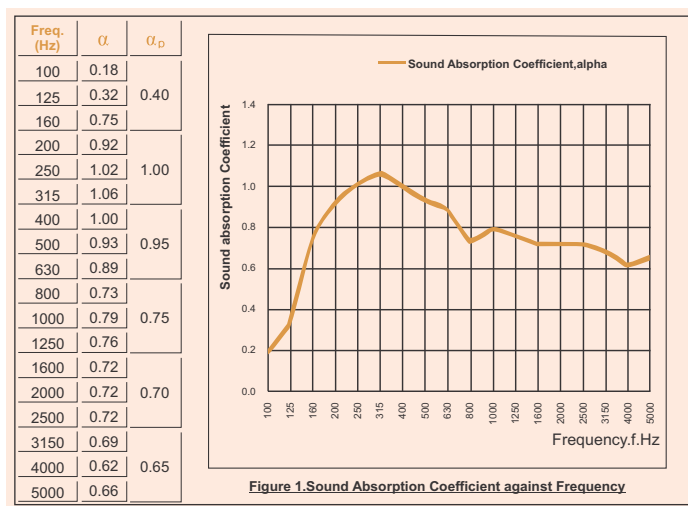
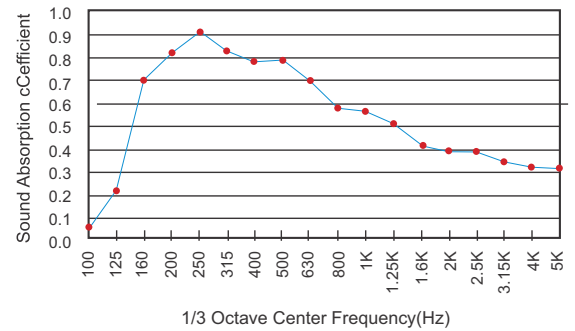

Linear Groove 13-3: NRC of 0.86 with Acoustic backing & Gap of 100mm.

## APPLICATIONS





## COLOR PATTERNS



*TREW 006 Elegant  
Walnut*



*TREW 007 Oak  
White*



*TREW 011 Light  
Cherry*

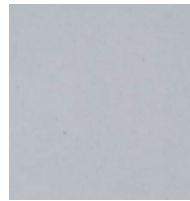

*TREW 012 Frosty  
Grey*

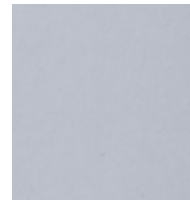

*TREW 014 Arctic  
White*



*TREW 015 Bliss  
Walnut*



*TREW 019 Tuscany  
Walnut*



*TREW 020 Maple*



*TREW 025 Brazilian  
Cherry*

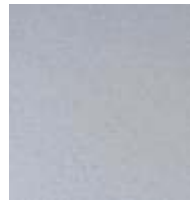

*TREW 026 Silver  
Grey*



*TREW 027 Cognac*

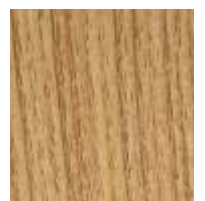

*TREW 028 Portland  
Oak*



*TREW 035 Dark  
Brazilian Cherry*



*TREW 042 Plateau  
Teak*



*TREW 043 Merbau*



*TREW 045 Dark Oak*



*TREW 046 Atlas  
Cherry*



*TREW 048 Beech*



*TREW 052 Borneo  
Teak*



*TREW 101 Bright  
White*

## DESIGN PATTERNS

### CUSTOM DESIGNS



CS 1001



CS 1002



CS 1003



CS 1004



CS 1005



CS 1006



CS 1007



CS 1008



CS 1009



CS 1010



CS 1011



CS 1012



CS 1013



CS 10014



S56D Slots



S56 Slots



S32 Square



SI100 Slots Offset

### PERFORATED



P616D Holes

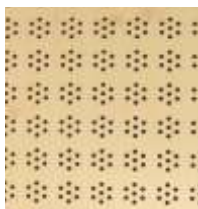

Pf3 Holes



P616 Holes



P416 Holes



P816 Holes



P932 Holes



Pf1 Holes



P316 Holes



Pf05

DIFFUSERS



*1D Diffuser*



*2D Diffuser*



*3D Pyramid Diffuser*



*Diffuser 36*



*Diffuser 101*



*Diffuser 104*



*Diffuser-J10*



*Diffuser 6020*



*Diffuser-DF-30*



*Diffuser 105*



*Diffuser 106*



*Diffuser-6T*



*Pyramid*



*Radius*

LINEAR



*Grooves 168*



*Grooves 324*



*Grooves 816*





# AKUSTİKSAN

Adil Mah. Pelit Sk. 66 İstanbul/Sultanbeyli 34920

P: +90 (216) 592 50 66 M: +90 532 452 26 74

E: destek@akustiksan.com.tr

[www.akustiksan.com.tr](http://www.akustiksan.com.tr)